

ggland examples

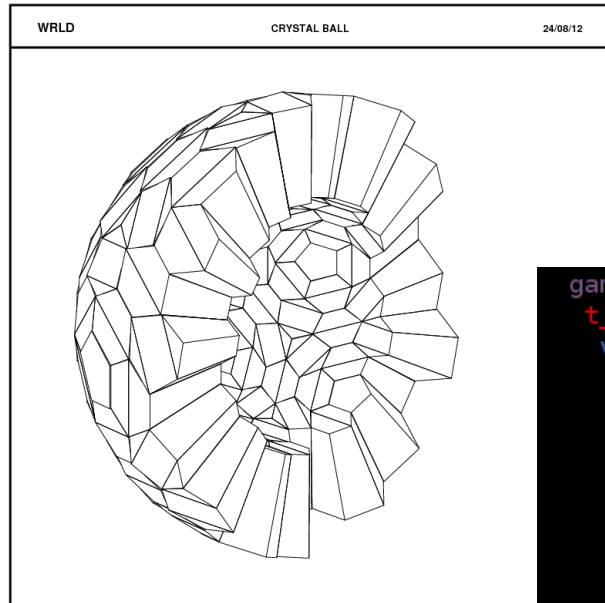

```
gamma: [1] pxyz=( -8.537, -1.231, -5.059) T= 10.000
t_delay= 0.000 pdg=22 te= 0.032 se= 0.968 # pid=1
vertex: t= 0.032 xyz=( -0.827, -0.119, -0.490) s= 0.968
PAIR pxyz=( -8.537, -1.231, -5.059) STOP T= 10.000 {
e+: [2] pxyz=( -2.856, -0.591, -1.332) T= 2.736
t_delay= 0.000 pdg=-11 te= 0.054 se= 0.604 # pid=2
vertex: t= 0.042 xyz=( -0.973, -0.200, -0.582) s= 0.272
BREM pxyz=( 0.842, -1.470, 0.158) T= 1.266 {
gamma: [3] pxyz=( 0.273, -0.253, 0.185) T= 0.416
t_delay= 0.000 pdg=22 te= 101.588 se= escape # pid=1
}
vertex: t= 0.054 xyz=( -0.949, -0.231, -0.561) s= 0.604
ANNI pxyz=( 0.000, -0.000, -0.000) STOP T= 0.000 {
gamma: [4] pxyz=( -0.065, -0.125, 0.491) T= 0.511
t_delay= 0.000 pdg=22 te= 69.472 se= escape # pid=1
gamma: [5] pxyz=( 0.065, 0.125, -0.491) T= 0.511
```

Håkan T. Johansson, Chalmers, Göteborg

January 2013 (minor updates Jan 2016)

Getting started (@ chalmers/sub-linux)

Download & compile:

Work directory

```
BASE=/net/data1/htj/ggland/
```

```
cd $BASE
```

```
cvs -d :ext:land@lx-pool.gsi.de:/u/johansso/CVS co land02
```

```
cd land02/scripts/ggland
```

```
make land_geant4
```

```
make -C ../../util/hbook root_writer
```

Running:

```
. geant4.sh          # Setup environment (planck-o)  
/net/data1/htj/ggland/land02/scripts/ggland/land_geant4
```

```
GG=/net/data1/htj/ggland/land02/scripts/ggland/
```

Example 1 - e^- in a box

```
GG=/net/data1/htj/ggland/land02/scripts/ggland/
```

```
$GG/land_geant4 --test=d=1cm,z0=2cm,type=Ge,out_col=0 \  
--gun=T=1MeV,e- \  
grep TSTDMP | sed -e "s/#.*//" -e "s/.*:/"
```

Output formatting

Output:

```
0.99881  
0.99906  
0.49163  
0.99759  
0.99386  
0.37398  
0.99842  
0.99763  
0.29450  
0.99929
```

Units: MeV

Why not 1.00?

Particle gun

Particle: e^-
Kinetic energy: 1 MeV
(default direction: z)

Test volume

Half-side: $d = 1$ cm
Material: Ge
Center at: $z = 2$ cm

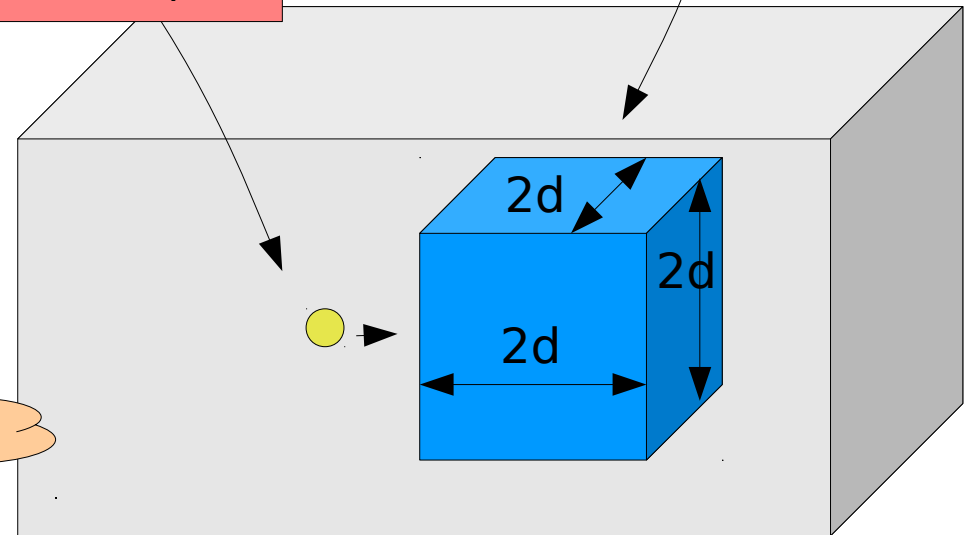

Example 2 - world vacuum

```
$GG/land_geant4 --test=d=1cm,z0=2cm,type=Ge,out_col=0 \  
--gun=T=1MeV,e- \  
--world=type=vacuum | \  
grep TSTDMP | sed -e "s/#.*//" -e "s/.*:/"
```

World volume

Material: vacuum

(default size: $d = 20$ m)

Output:

```
1.00000  
0.72242  
1.00000  
1.00000  
0.42274  
1.00000  
1.00000  
1.00000  
1.00000  
1.00000  
1.00000
```

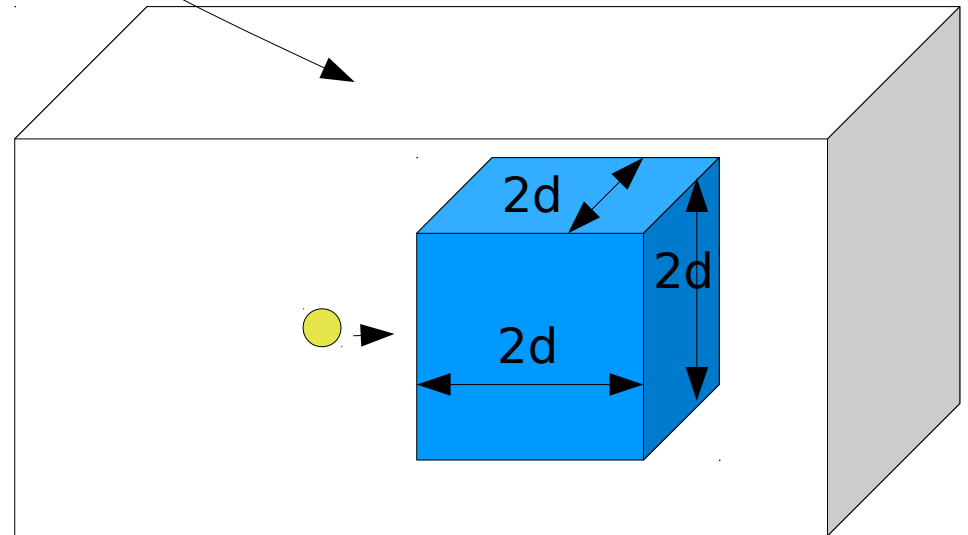

Example 3 - root tree

```
$GG/land_geant4 --test=d=1cm,z0=2cm,type=Ge,tree=1 \  
--gun=T=1MeV,gamma --world=type=vacuum \  
--events=10000 --tree=example3.root
```

More events!

Output root tree

Filename: **example3.root**

```
root -l example3.root
```

```
_file0->ls()  
_h102->Print()  
_h102->Draw("TSTe")
```

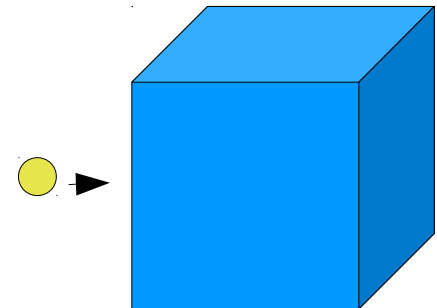
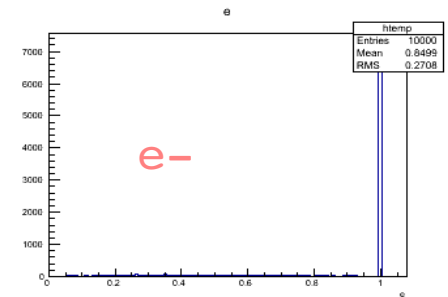
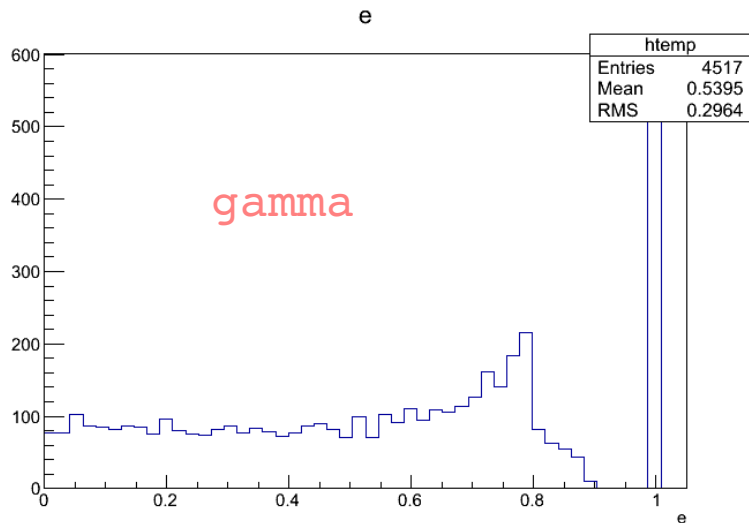

Example 4 - zero-suppression

```
$GG/land_geant4 --test=d=10cm,z0=20cm,type=plastic,tree=1 \  
--gun=T=1MeV,gamma --world=type=vacuum \  
--events=10000 --tree=example4.root
```

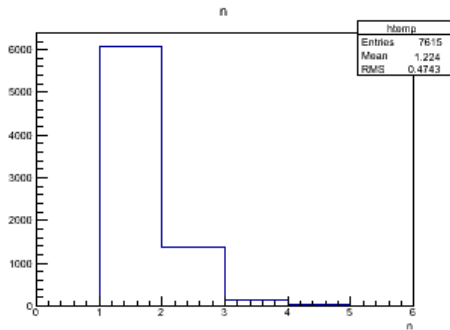

```
root -l example4.root
```

```
h102->Print()  
h102->Draw("TSTn")  
h102->Draw("TSTe")  
h102->Draw("TSTsumE")
```

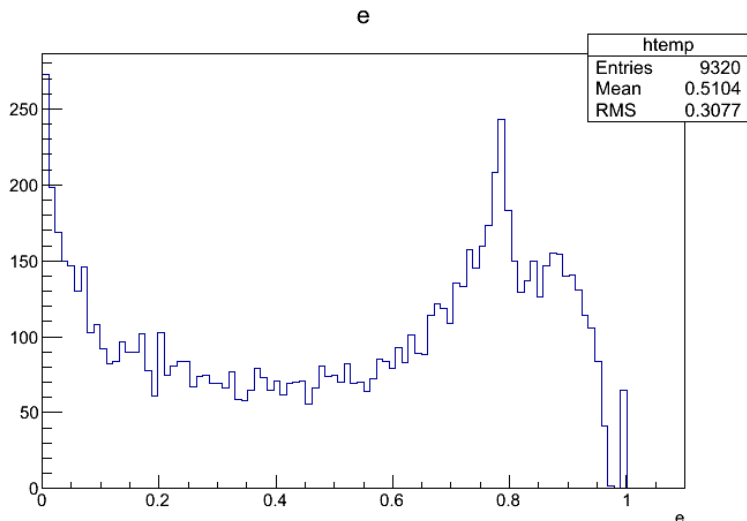
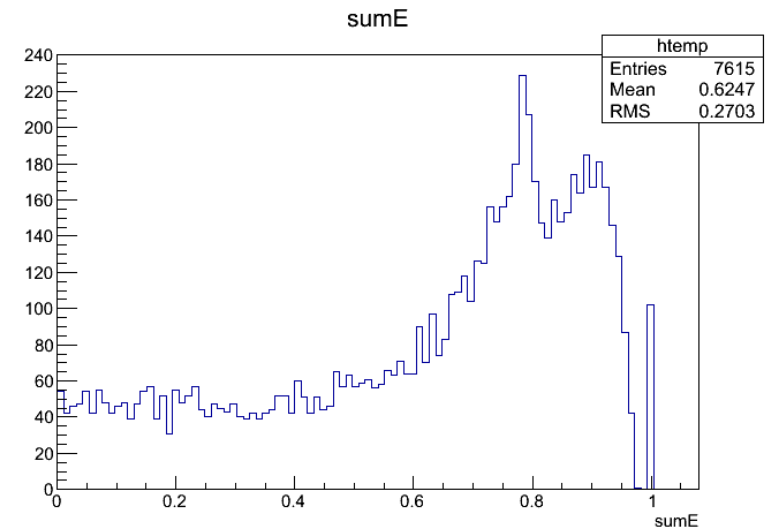

```
TSTsumE  
TSTn  
TSTx[n]  
TSTy[n]  
TSTz[n]  
TSTe[n]  
TSTt[n]
```

Total

'Clusters'
(max 10)

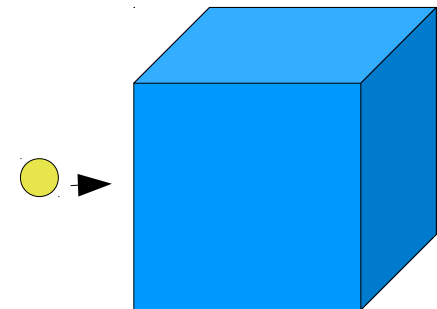

Example 5 - coincidences

```
$GG/land_geant4 --events=1000000 --tree=example5.root \  
--test-1=d=1cm,z0=2cm,type=Ge,tree=1 \  
--test-2=d=1cm,z0=2cm,y0=2cm,type=Ge,tree=1 \  
--gun=T=1MeV,gamma --world=type=vacuum
```

```
root -l example5.root
```

```
h102->Draw("TST1sumE:TST2sumE")
```

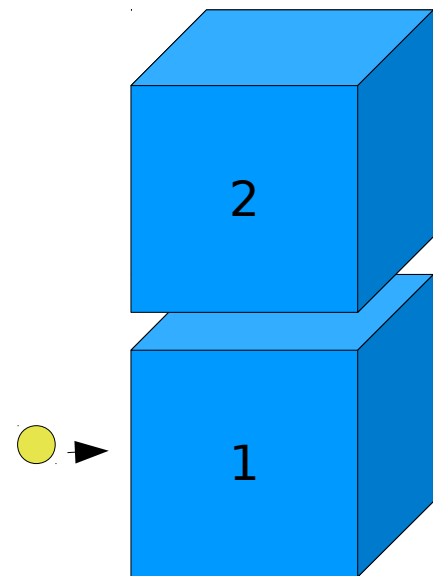
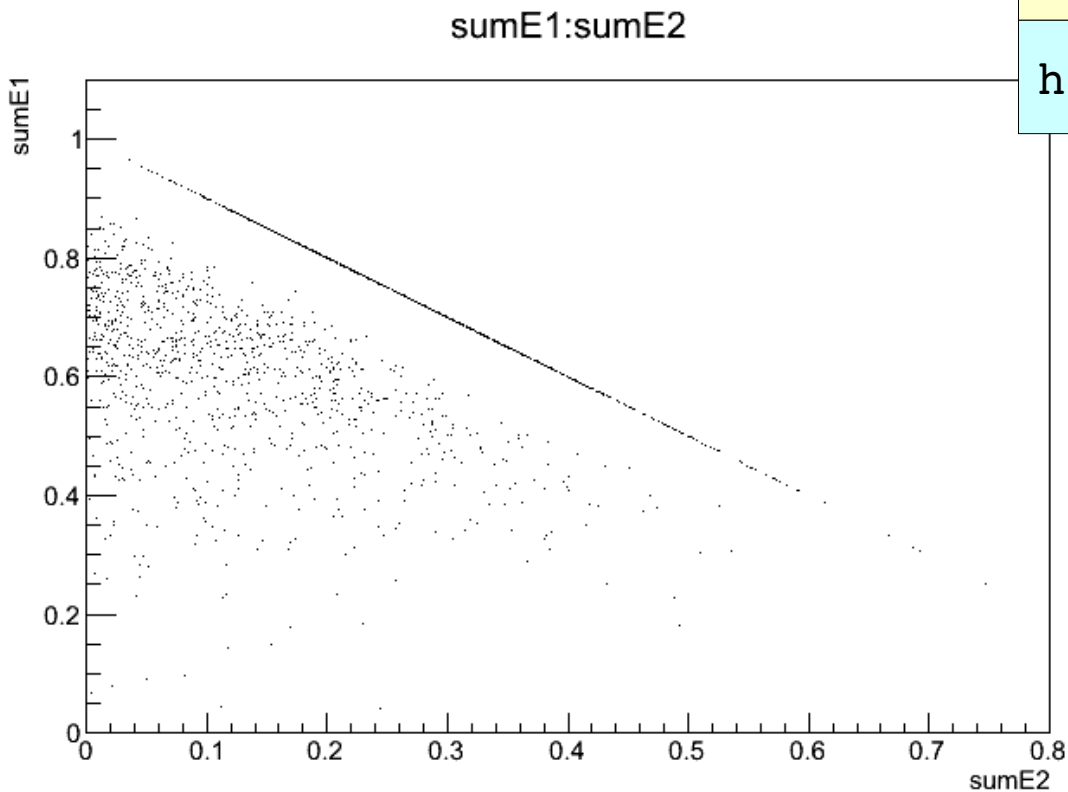

Data flow

Reconstruction flow: ↓

Simulation starts at the level where analysis ends;

Simulation flow: ↑

Flow ↑ until suitable handover point:

(land02-speak:) SYNC level

ggland: wrap GEANT3/4

ggdigi: combine 'δE-hits'

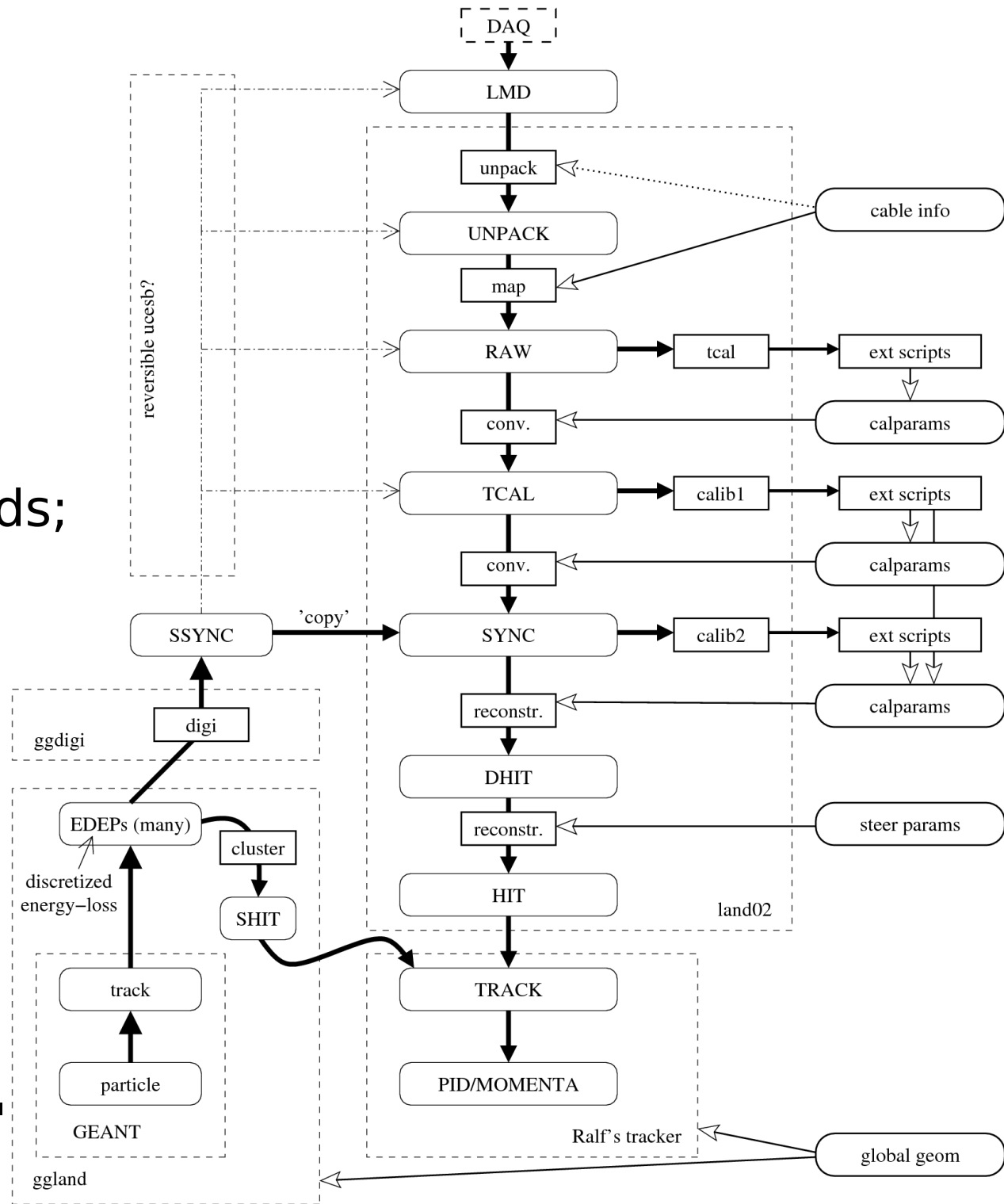

SYNC level data (t,e) → **land02**

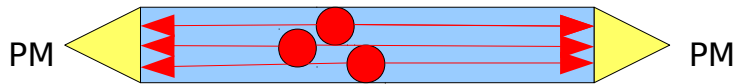

ggdigi: propagate δE -signals to readout, sum & discriminate

GEANT: gives ' δE -hits' (●)

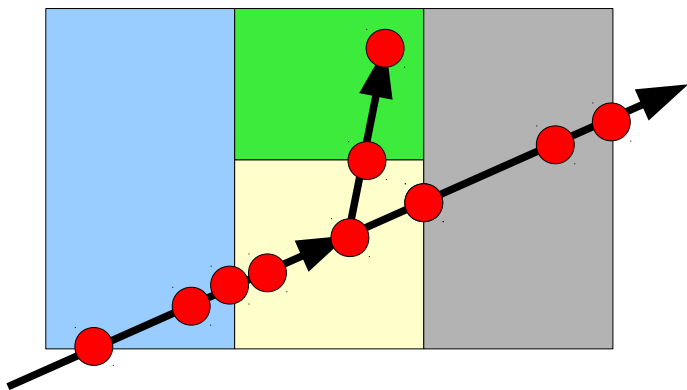

GEANT: particles & tracks

ggland: minimalistic interface

ggland & ggdigi

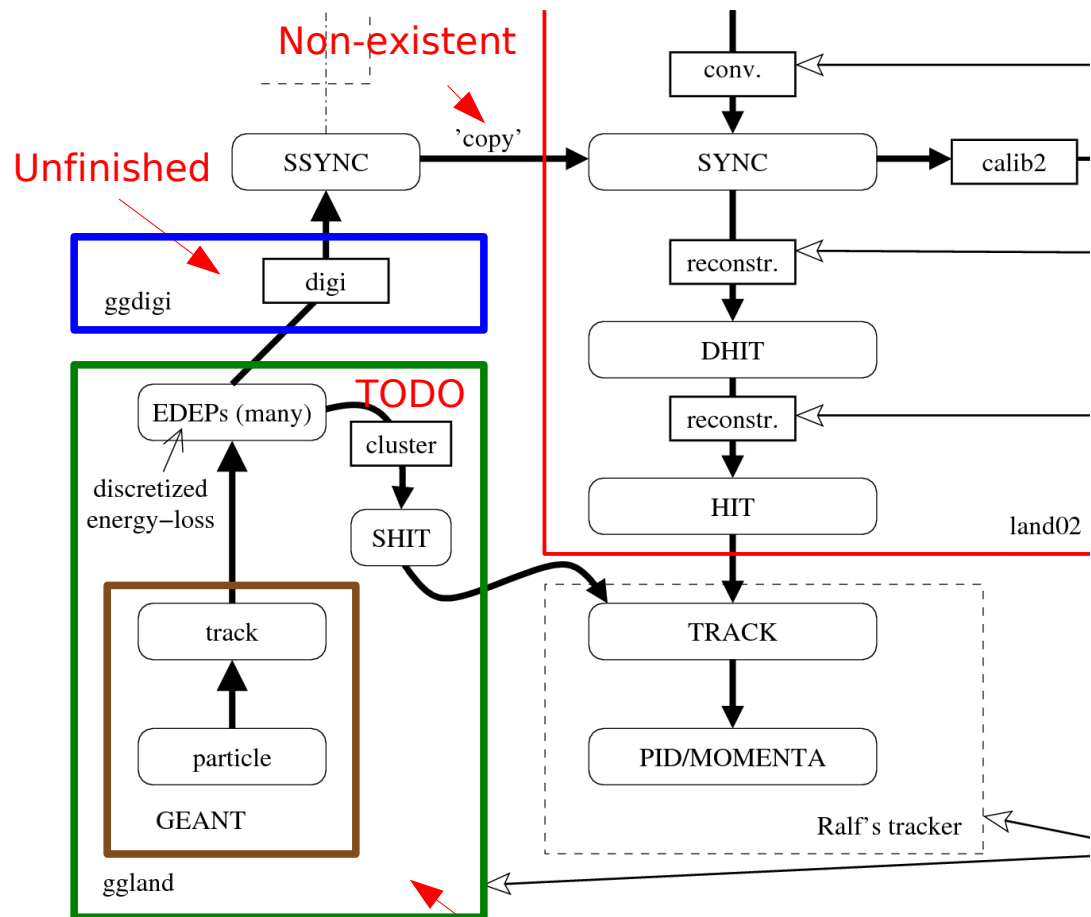

More detectors needed...

Read this way

ggland: Interfacing with GEANT3/4

Interface to **GEANT3**:
6 user-defined functions
(FORTRAN, easy to call
From C).

GEANT4 has similar
'mechanics', but more
flexible and C++.

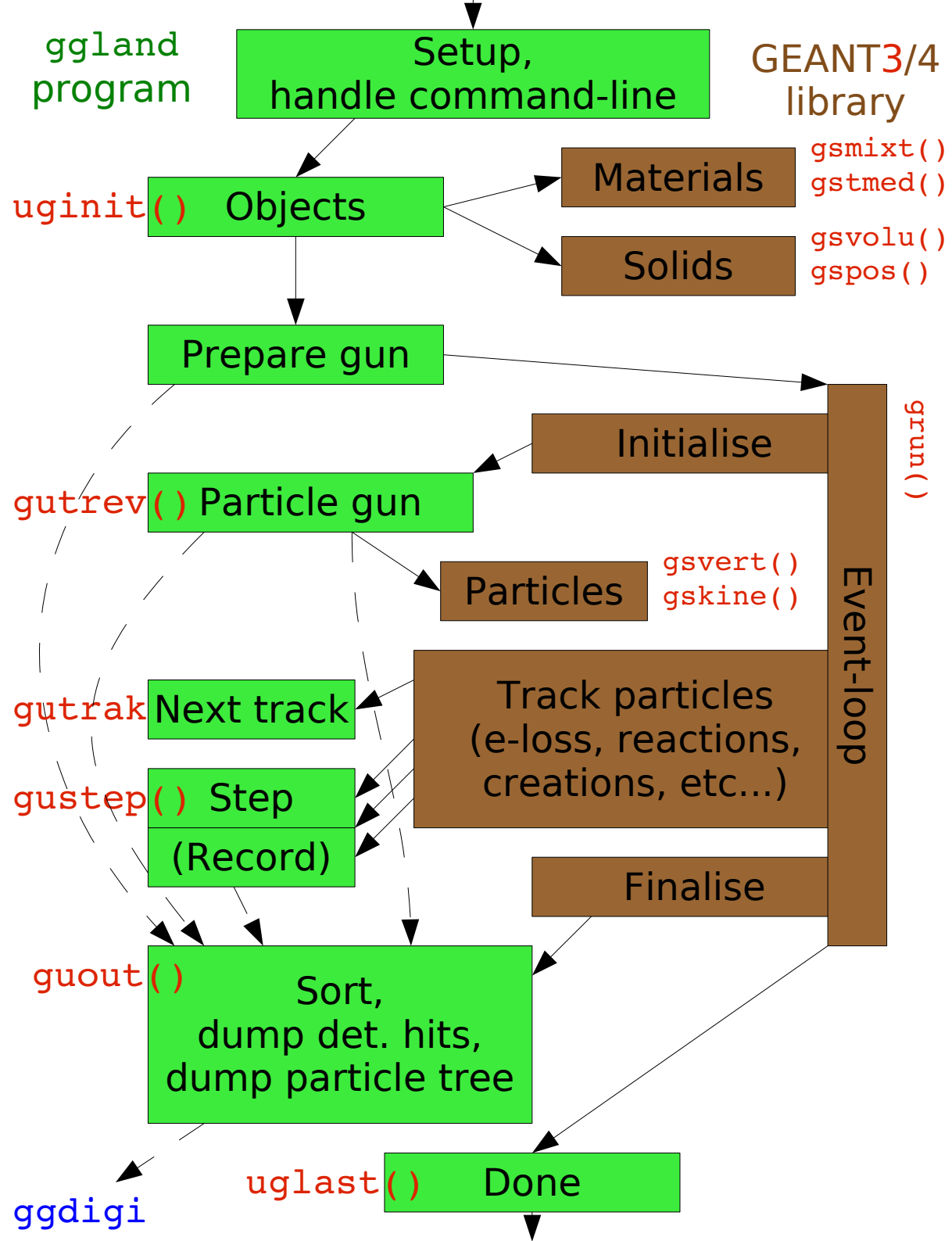

ggdigi: Generic digitisation

Simulation generates list of energy deposits in volumes

```
*** EVENT 5 *** # seeds: 885310761,1134865903
hits: LAND: # 3, 2 sections
1/18: # LAND, 2 hits (E=18.792)
t= 41.189 p=-99.97 dE= 10.906 ds= 0.865
t= 41.209 p=-99.29 dE= 7.886 ds= 1.125
1/19: # LAND, 1 hits (E=3.674)
t= 41.280 p=-99.35 dE= 3.674 ds= 0.490
# total E=22.466
```

```
1: # TEST, 49 hits (E=9.073)
t= 0.032 p=-0.49 dE= 0.000 ds= 0.000 # 2
t= 0.032 p=-0.49 dE= 0.000 ds= 0.000 # 7
t= 0.032 p=-0.49 dE= 0.000 ds= 0.968 # 1
t= 0.035 p=-0.51 dE= 0.316 ds= 0.072 # 2
t= 0.037 p=-0.56 dE= 0.173 ds= 0.057 # 2
t= 0.038 p=-0.58 dE= 0.185 ds= 0.051 # 2
t= 0.038 p=-0.58 dE= 0.852 ds= 0.183 # 7
t= 0.040 p=-0.59 dE= 0.197 ds= 0.043 # 2
t= 0.041 p=-0.58 dE= 0.161 ds= 0.039 # 2
t= 0.042 p=-0.58 dE= 0.022 ds= 0.009 # 2
t= 0.043 p=-0.58 dE= 0.113 ds= 0.035 # 2
t= 0.044 p=-0.57 dE= 0.716 ds= 0.163 # 7
t= 0.044 p=-0.58 dE= 0.129 ds= 0.035 # 2
t= 0.045 p=-0.57 dE= 0.126 ds= 0.035 # 2
t= 0.047 p=-0.56 dE= 0.108 ds= 0.035 # 2
t= 0.048 p=-0.54 dE= 0.107 ds= 0.035 # 2
t= 0.048 p=-0.55 dE= 0.000 ds= 0.000 # 8
t= 0.048 p=-0.55 dE= 0.622 ds= 0.127 # 7
t= 0.049 p=-0.55 dE= 0.024 ds= 0.014 # 8
t= 0.049 p=-0.57 dE= 0.118 ds= 0.035 # 2
t= 0.050 p=-0.58 dE= 0.000 ds= 0.000 # 9
t= 0.050 p=-0.58 dE= 0.388 ds= 0.063 # 7
t= 0.051 p=-0.57 dE= 0.115 ds= 0.035 # 2
t= 0.051 p=-0.59 dE= 0.038 ds= 0.011 # 9
t= 0.052 p=-0.56 dE= 0.123 ds= 0.035 # 2
t= 0.054 p=-0.56 dE= 0.000 ds= 0.000 # 4
t= 0.054 p=-0.56 dE= 0.000 ds= 0.000 # 5
t= 0.054 p=-0.56 dE= 0.143 ds= 0.012 # 2
```

Often many!
Depends on discretization.

Analysis needs single data per readout channel (like real data)

Digitiser propagates to readout:

- Time-delay $t += d * v_{\text{eff}}$
- Attenuation $e *= \exp(-d/l_{\text{att.len.}})$

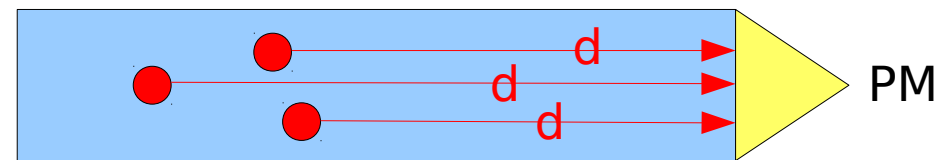

- Each hit contributes to readout pulse.
- Final time-signal after CFD (or LE) mimic

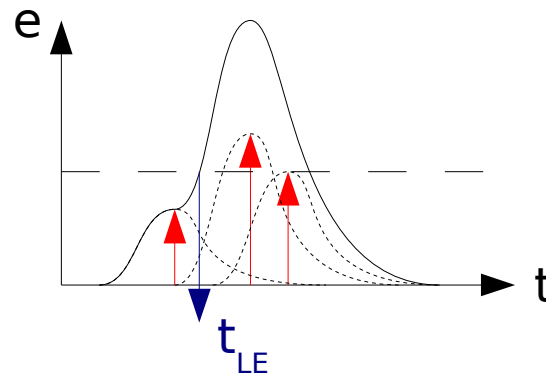

Propagation and CFD based on R3BConstantFraction.
{h,cxx}
By Johan Gill & Staffan Wranne

ggdigi: Generic digitisation II

```
*** EVENT 5 *** # seeds: 885310761,1134865903
hits: LAND: # 3, 2 sections
1/18: # LAND, 2 hits (E=18.792)
      t= 41.189 p=-99.97 dE= 10.906 ds= 0.865
      t= 41.209 p=-99.29 dE= 7.886 ds= 1.125
1/19: # LAND, 1 hits (E=3.674)
      t= 41.280 p=-99.35 dE= 3.674 ds= 0.490
# total E=22.466
```

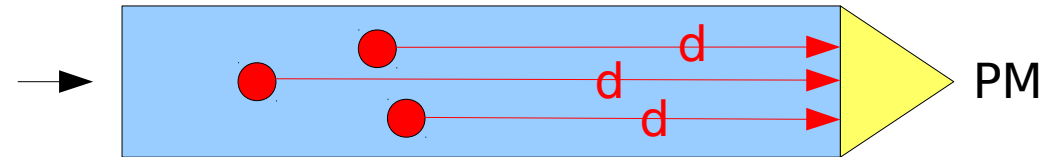

```
*** EVENT 5 ***
# LAND 2 sections 3 hits
1/18: t1= 35.189 e1= 10.079 t2= 47.202 e2= 35.039
1/19: t1= 35.295 e1= 1.975 t2= 47.265 e2= 6.836
```

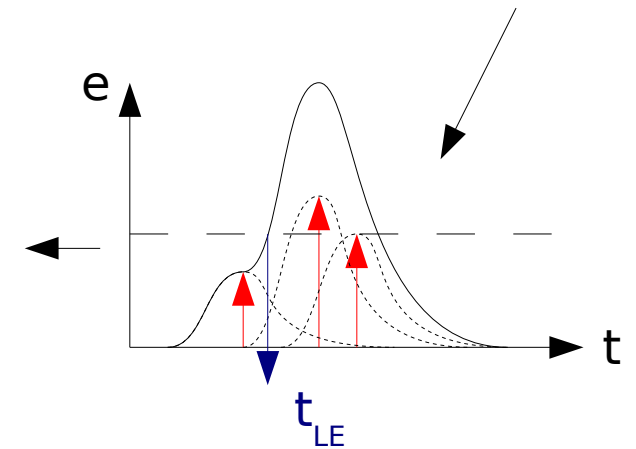

ggdigi: Separate process, same routine for all detectors!

Customised by:

- Relevant propagation coordinate
- Speed of signal, e.g. v_{eff} of scintillation photons
- Attenuation length
- (To handle Birk's law - light output saturation)

Parametrised detectors

Detector volumes created by C code,
by calling wrappers for **GEANT3/4**.

Dimensions and aspects variable controlled.
Defaults give 'normal' detectors.
Override on command line.

Existing:

```
--land  
--sciland  
--xb  
--csi  
--cave  
--boxcave  
--test  
--world
```

`--xb=help`

<code>rot{x,y,z} x0 y0 z0</code>	<code>0 1 cm</code>	Rotation Location.
<code>r1</code>	<code>25 cm</code>	Inner radius.
<code>r2</code>	<code>45 cm</code>	Outer radius.
<code>right</code>	<code>1</code>	Right half (1-81,!77,!81).
<code>left</code>	<code>1</code>	Left half (83-162,!82).
<code>forward</code>	<code>0</code>	Forward crystal (81).
<code>backward</code>	<code>0</code>	Backward crystal (82).
<code>bottom</code>	<code>0</code>	Bottom crystal (77).
<code>all</code>	<code>0</code>	Enable all crystals.
<code>crystal</code>	<code>NaI</code>	Crystal material.

TEST volume

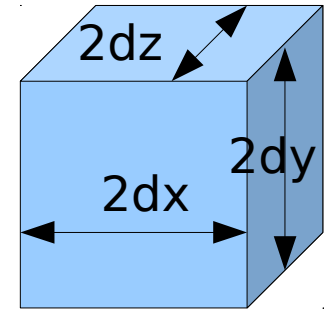

--test=help

rot{x,y,z} x0 y0 z0	0 1 cm	Rotation Location.
d	1 cm	Half width (if none of dx,dy,dz given).
dx	1 cm	Half width (x).
dy	1 cm	Half width (y).
dz	1 cm	Half width (z).
dm	nan g/cm2	Thickness (if none of dx,dy,dz given).
dmx	nan g/cm2	Thickness (x).
dmy	nan g/cm2	Thickness (y).
dmz	nan g/cm2	Thickness (z).
out_col	-1	Output column. (Text dump.)
stepprint	0	Debug printing from the step function.
type	undefined	Test material.



Material must be given
for test volume:

--list-materials

Energy sum per event.
First column is 0.
(Only non-0 events printed.)
For ROOT's Ttree::ReadFile()

test3.txt:

```
0.71876
0.05768
0.00663
0.68386
0.06915
0.79547
0.61802
0.69747
0.07892
...
```

Multiple TEST volumes

```
./land_geant3
--test-0=d=0.5cm,z0=1cm,type=plastic,out_col=0
--test-1=d=0.5cm,z0=2cm,type=plastic,out_col=1
--test-2=d=0.5cm,z0=3cm,type=plastic,out_col=2
--gun=gamma,T=10MeV,dtheta=0.5pi --events=1000000 |
grep TSTDMP | sed -e "s/.*/:/" > 3vols.txt
```

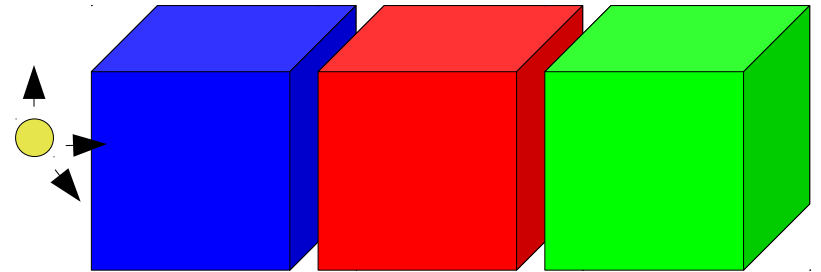

3vols.txt:

```
2.26846 0.00000 0.00000
2.14312 1.33287 0.00000
0.95297 0.00000 0.00000
0.07750 0.00000 0.00000
0.27885 0.00000 0.00000
0.00000 1.23321 0.00000
0.53523 0.93503 0.00000
1.06333 0.00000 0.00000
0.00000 0.79065 0.00000
3.89404 1.62902 0.00000
0.14590 2.33030 1.07062
0.00000 0.00000 0.47722
0.00000 1.79729 2.36696
0.93408 0.00000 0.00000
```

...

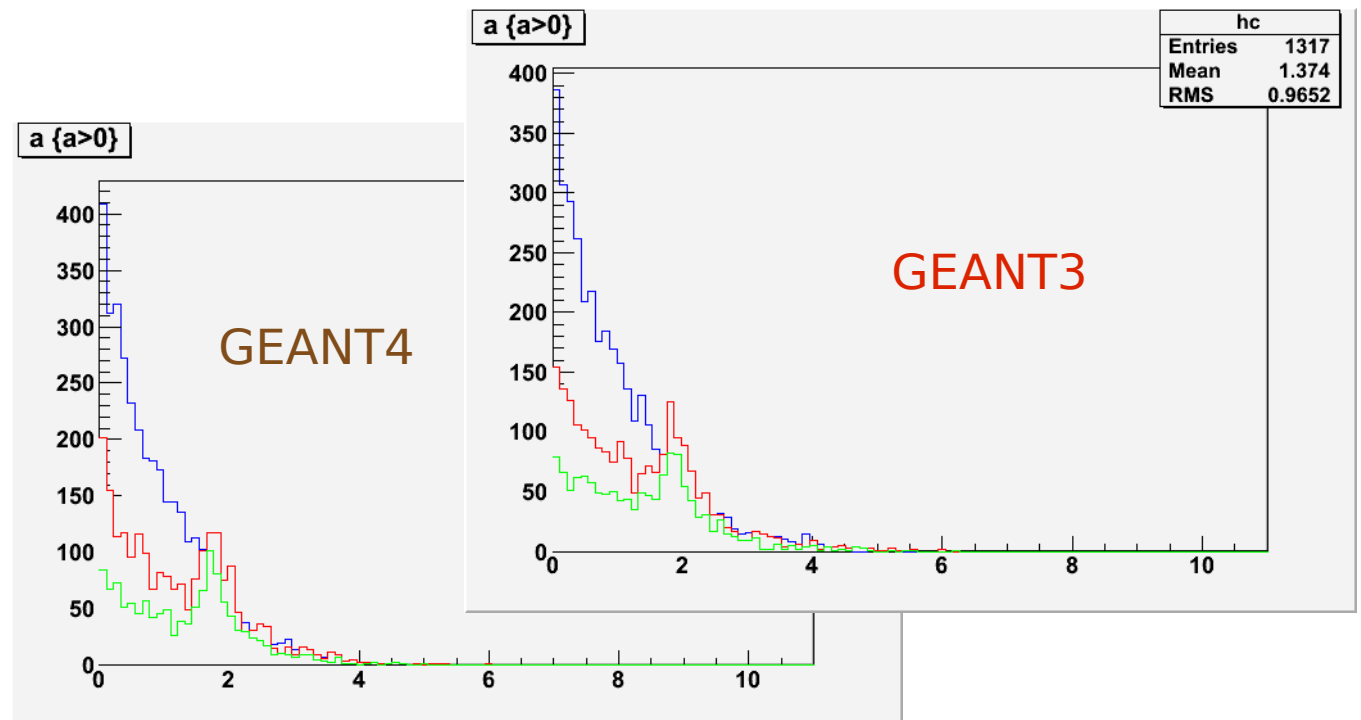



Instant .root-file

Back-of-the-envelope simulations

Create root-file with data from test volumes:

sumE

By rough 'digitizer': cluster by distance (currently $\sqrt{10}$ cm):

$n, x[n], y[n], z[n], t[n], e[n]$



```
./land_geant4 --test=dx=125cm,dy=2.5cm,dz=2.5cm,type=plastic,tree=1
--gun=cosmmuonthetaE=250MeV,sr=130cm --tree=muons2.root
--events=1000000
```

Include volume

```
h101->Draw("e:x")
```

Realistic muon source now also gives corresponding real time.

Muon source (lowEcut=250.0 MeV, r=130.0 cm):
avg time between ev. 0.0009705 s.
Muon source with 1000000 events, total time:
970.5 s (= 0 h 16 m).

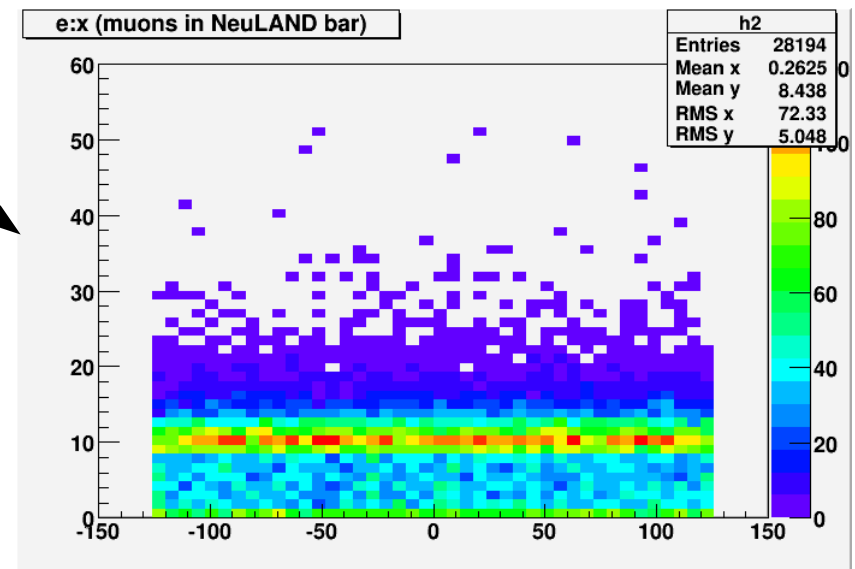

Vertex & hit list - markup: ggmark

```
--hits=vertex,- |  
./ggmark |  
less -R
```

Hit (δE) list

```
hits: TEST: # 49, 1 sections  
1: # TEST, 49 hits (E=9.073)  
t= 0.032 p= -0.49 dE= 0.000 ds= 0.000 # 2  
t= 0.032 p= -0.49 dE= 0.000 ds= 0.000 # 7  
t= 0.032 p= -0.49 dE= 0.000 ds= 0.968 # 1  
t= 0.035 p= -0.51 dE= 0.316 ds= 0.072 # 2  
t= 0.037 p= -0.56 dE= 0.173 ds= 0.057 # 2  
t= 0.038 p= -0.58 dE= 0.185 ds= 0.051 # 2  
t= 0.038 p= -0.58 dE= 0.852 ds= 0.183 # 7  
t= 0.040 p= -0.59 dE= 0.197 ds= 0.043 # 2  
t= 0.041 p= -0.58 dE= 0.161 ds= 0.039 # 2  
t= 0.042 p= -0.58 dE= 0.022 ds= 0.009 # 2  
t= 0.043 p= -0.58 dE= 0.113 ds= 0.035 # 2  
t= 0.044 p= -0.57 dE= 0.716 ds= 0.163 # 7  
t= 0.044 p= -0.58 dE= 0.129 ds= 0.035 # 2  
t= 0.045 p= -0.57 dE= 0.126 ds= 0.035 # 2  
t= 0.047 p= -0.56 dE= 0.108 ds= 0.035 # 2  
t= 0.048 p= -0.54 dE= 0.107 ds= 0.035 # 2  
t= 0.048 p= -0.55 dE= 0.000 ds= 0.000 # 8  
t= 0.048 p= -0.55 dE= 0.622 ds= 0.127 # 7  
t= 0.049 p= -0.55 dE= 0.024 ds= 0.014 # 8  
t= 0.049 p= -0.57 dE= 0.118 ds= 0.035 # 2  
t= 0.050 p= -0.58 dE= 0.000 ds= 0.000 # 9  
t= 0.050 p= -0.58 dE= 0.388 ds= 0.063 # 7  
t= 0.051 p= -0.57 dE= 0.113 ds= 0.035 # 2  
t= 0.051 p= -0.59 dE= 0.038 ds= 0.011 # 9  
t= 0.052 p= -0.56 dE= 0.123 ds= 0.035 # 2  
t= 0.054 p= -0.56 dE= 0.000 ds= 0.000 # 4  
t= 0.054 p= -0.56 dE= 0.000 ds= 0.000 # 5  
t= 0.054 p= -0.56 dE= 0.143 ds= 0.012 # 2
```

Particle-hit
association

Particle & vertex list

```
*** EVENT 5 *** # seeds: 55312060,333625511  
# Vertices 7, particles 9  
# bullet pdg=22 T= 10.000 theta=120.394deg phi=-171.797deg gamma  
origin: t= 0.000 xyz=( 0.000, 0.000, 0.000) {  
  gamma: [1] pxyz=( -8.537, -1.231, -5.059) T= 10.000  
  t_delay= 0.000 pdg=22 te= 0.032 se= 0.968 # pid=1  
  vertex: t= 0.032 xyz=( -0.827, -0.119, -0.490) s= 0.968  
    PAIR pxyz=( -8.537, -1.231, -5.059) STOP T= 10.000 {  
  e+: [2] pxyz=( -2.856, -0.591, -1.332) T= 2.736  
  t_delay= 0.000 pdg=-11 te= 0.054 se= 0.604 # pid=2  
  vertex: t= 0.042 xyz=( -0.973, -0.200, -0.582) s= 0.272  
    BREM pxyz=( 0.842, -1.470, 0.158) T= 1.266 {  
  gamma: [3] pxyz=( 0.273, -0.253, 0.185) T= 0.416  
  t_delay= 0.000 pdg=22 te= 101.588 se= escape # pid=1  
  }  
  vertex: t= 0.054 xyz=( -0.949, -0.231, -0.561) s= 0.604  
    ANNI pxyz=( 0.000, -0.000, -0.000) STOP T= 0.000 {  
  gamma: [4] pxyz=( -0.065, -0.125, 0.491) T= 0.511  
  t_delay= 0.000 pdg=22 te= 69.472 se= escape # pid=1  
  gamma: [5] pxyz=( 0.065, 0.125, -0.491) T= 0.511  
  t_delay= 0.000 pdg=22 te= 0.069 se= 0.451 # pid=1  
  vertex: t= 0.062 xyz=( -0.916, -0.169, -0.804) s= 0.253  
    COMP pxyz=( 0.192, 0.135, 0.078) T= 0.247 {  
  e-: [6] pxyz=( -0.126, -0.010, -0.569) T= 0.264  
  t_delay= 0.000 pdg=11 te= 0.062 se= 0.035 # pid=3  
  }  
  }  
  e-: [7] pxyz=( -5.603, -0.628, -3.681) T= 6.242  
  t_delay= 0.000 pdg=11 te= 0.071 se= 1.161 # pid=3  
  vertex: t= 0.048 xyz=( -0.794, -0.314, -0.546) s= 0.473  
    BREM pxyz=( 1.088, 3.664, -2.395) T= 4.028 {  
  gamma: [8] pxyz=( 0.007, 0.018, -0.014) T= 0.024  
  t_delay= 0.000 pdg=22 te= 0.049 se= 0.014 # pid=1  
  }  
  vertex: t= 0.050 xyz=( -0.780, -0.268, -0.576) s= 0.535  
    BREM pxyz=( 1.443, 0.913, -3.707) T= 3.602 {  
  gamma: [9] pxyz=( 0.014, 0.010, -0.034) T= 0.038  
  t_delay= 0.000 pdg=22 te= 0.051 se= 0.011 # pid=1  
  }  
  }  
}
```

Versatile particle gun

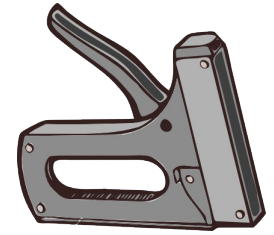

--gun=isotropic, gamma, E=5MeV

--gun=z0=10cm, sr=0.1cm, sphere, theta=45deg,
dtheta=0.5pi, C12, T=200MeV/u

--gun=help

- Tree / conditional emission
- Source location & shape
- Direction and emission opening
- Energy / momentum
- Particle selection
- Phase-space / Lorentz boost

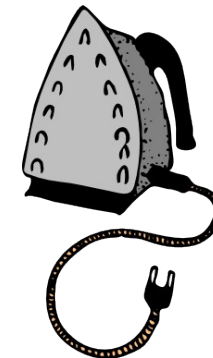

ggland - TODO

More detectors (POS, SST, GFI, NTF, PDC, TFW)

Mimic of QFS - (p,2p) / (p,np) – in particle gun

Quick-n-dirty digitizer/tree writer for detectors

Magnetic field (ALADiN)

Needed for project

Nice to have

Gun from file (bullets)

Auto-plot of visualisation around (interesting) vertices

???

Detector definition sources

```
dets, land, xb, box_cave, cave
```

```
geom_<DET>.{hh,cc} // detector definitions  
{gg,g3,g4}_geom_help.{hh,cc} // used by the definitions
```

Geant3 geometry package:

http://wwwasdoc.web.cern.ch/wwwasdoc/geant_html3/node94.html

Geant3 shapes:

<http://wwwasdoc.web.cern.ch/wwwasdoc/geant/node109.html>

Geant4 geometry is very similar:

<http://geant4.web.cern.ch/geant4/UserDocumentation/UsersGuides/ForApplicationDeveloper/html/ch04.html>

We will mostly need boxes...

mini-scripting

Command line becoming long?

```
./land_geant3  
--test-0=d=0.5cm,z0=1cm,type=plastic,out_col=0  
--test-1=d=0.5cm,z0=2cm,type=plastic,out_col=1  
--test-2=d=0.5cm,z0=3cm,type=plastic,out_col=2  
--gun=gamma,T=10MeV,dtheta=0.5pi --events=1000000 |  
grep TSTDMP | sed -e "s/.*: //" > 3vols.txt
```

Shell script:

Got a problem?
Odds against you?
Call the Equalizer.